

---

## Multi Frequency Band Antennas

---

- Vehicle tracking
- Asset tracking
- GPS Navigation
- Wifi
- Bluetooth
- Telemetry

ADA-0400/1400 is a range of multi- frequency antennas for GSM, 3G, GPS and Wifi. The ADA-0400/1400 antennas are available in centre bolt, magnet mount as well as tape mount versions.



**RoHS**

## Specification

| Category                 | GPS   |
|--------------------------|---|
| Frequency                | 1575.42 MHz   |
| Polarization             | R.H.C.P.  |
| Power Gain               | Typ. 27 dB  |
| Noise figure             | Max 1.8   |
| Attenuation              | Min. 20 dB @ $F_o \pm 50$ MHz   |
| Bandwidth                | 2 MHz   |
| Output Impedance         | 50 $\Omega$   |
| VSWR                     | $\leq 2.0$  |
| Supply Voltage / Current | 3.0 – 5.5 VDC / 12 mA   |
| RF Cable                 | Standard 3 m RG174/U with standard connector  |
|                          | <b>GSM/UMTS/2400</b>  |
| Frequency                | 824 ~ 894 MHz (GSM 850MHz)<br>890 ~960 MHz (GSM 900MHz)<br>1710 ~1890 MHz (GSM 1800MHz)<br>1850 ~ 1990 MHz (PCS 1900MHz)<br>1922 ~ 2170 MHz (3G 2100 MHz)<br>2400 ~ 2483 MHz (2400 MHz) |
| Polarization             | Vertical Linear   |
| Gain                     | 850 MHz= 1.0 dBi    900 MHz= 1.0 dBi<br>1800 MHz= 1.0 dBi    1900 MHz= 1.0 dBi<br>2100 MHz= 0.0 dBi    2400 MHz= 0.0 dBi  |
| Impedance                | 50 $\Omega$   |
| VSWR                     | $\leq 2.0$  |
| Power                    | 10 W  |
| RF Cable                 | Standard 3 m RG174/U with standard connector  |
|                          | <b>Overall Performance</b>  |
| Size                     | 63 x 15.6 mm (D x H)  |
| Mounting                 | Centre bolt 12,7 x 19mm, Magnetic or Tape   |
| Operating temperature    | -40 — +80 ° C   |
| Storage temperature      | -45 — +100 ° C  |

**850MHz**

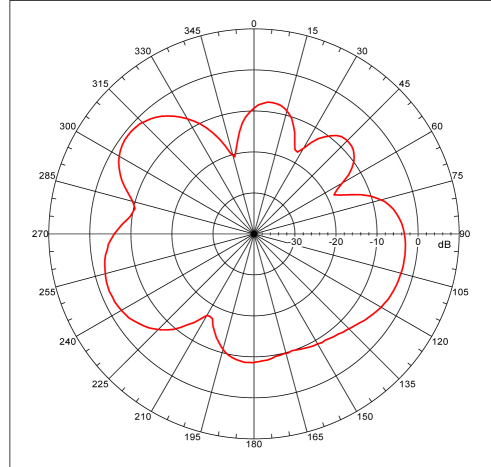
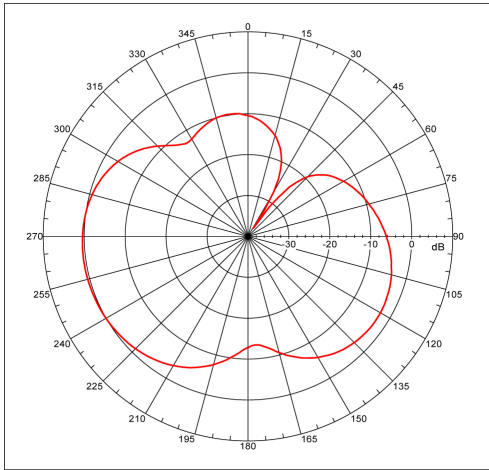

**900 MHz**

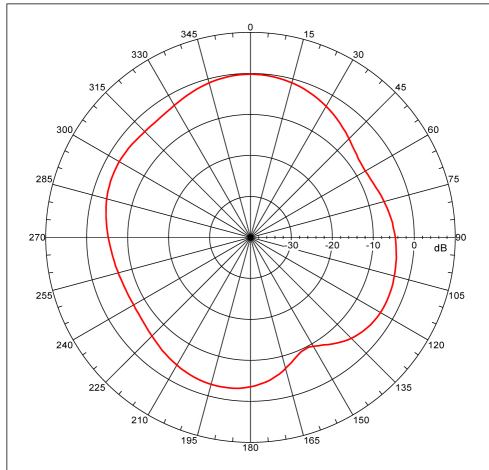

**2100 MHz**

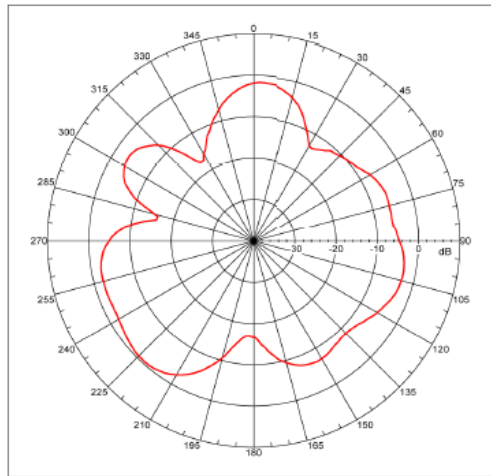

**1800 MHz**

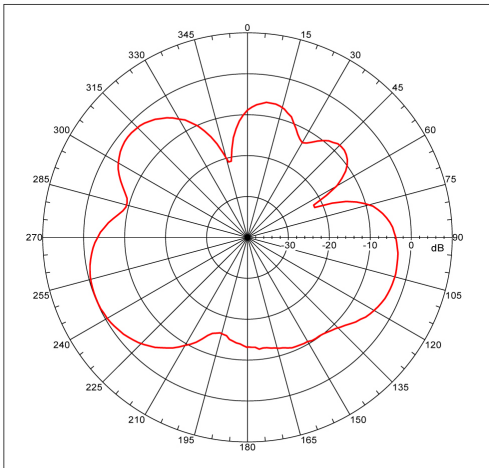

**2400 MHz**

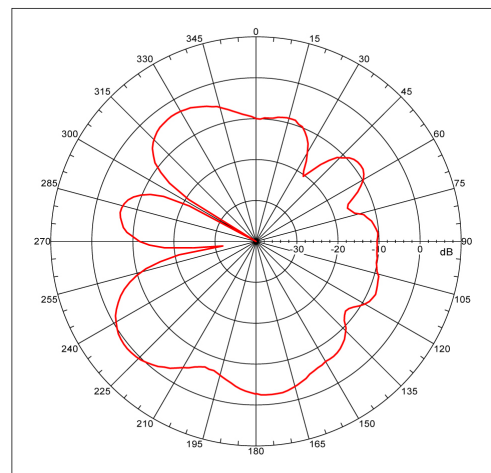

**1900 MHz**

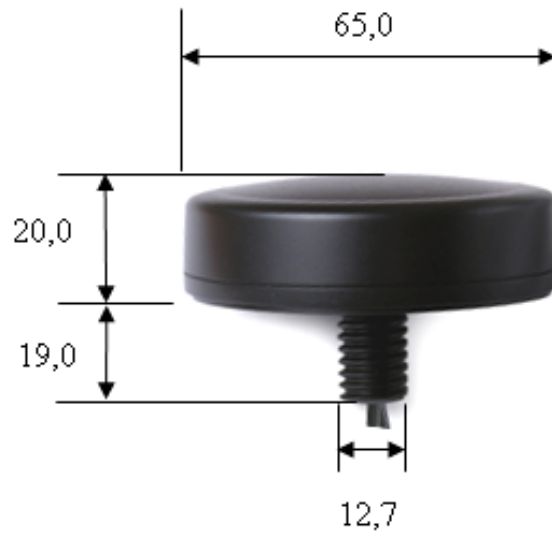
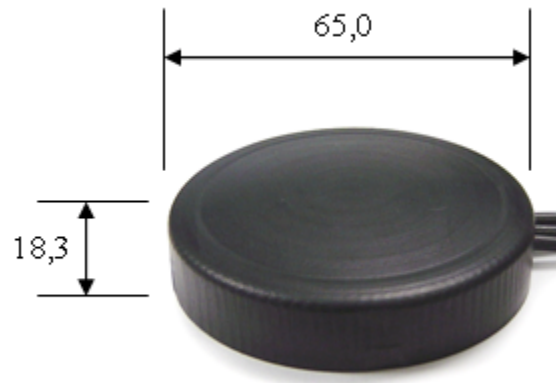

## Ordering codes

| TYPE       | GPS | 850 | 900 | 1800 | 1900 | 2100 | 2400 | No of cables |
|------------|-----|-----|-----|------|------|------|------|--------------|
| ADA-0410-x |     |     | X   | X    |      |      |      | 1            |
| ADA-0420-x |     | X   |     |      | X    |      |      | 1            |
| ADA-0430-x |     | X   | X   | X    | X    |      |      | 1            |
| ADA-0440-x |     | X   | X   | X    | X    | X    |      | 1            |
| ADA-0450-x |     | X   | X   | X    | X    | X    | X    | 2            |
| ADA-0460-x |     |     |     |      |      |      | X    | 1            |
| ADA-1410-x | X   |     | X   | X    |      |      |      | 2            |
| ADA-1420-x | X   | X   |     |      | X    |      |      | 2            |
| ADA-1430-x | X   | X   | X   | X    | X    |      |      | 2            |
| ADA-1440-x | X   | X   | X   | X    | X    | X    |      | 2            |
| ADA-1450-x | X   | X   | X   | X    | X    | X    | X    | 3            |
| ADA-1460-x | X   |     |     |      |      |      | X    | 2            |
| ADA-1470-x | X   |     |     |      |      |      |      | 1            |

x = C for Centre bolt mount  
 S for Magnetic mount  
 T for tape mount

The antennas are delivered with different antenna cable lengths and different connectors. Contact Adactus or our distributor for a quote for any particular specification.

For the latest updates, visit our Web site: [www.adactus.se](http://www.adactus.se)

### Disclaimer

Information furnished is believed to be accurate and reliable. However, Adactus assumes no responsibility for the consequences of use of such information nor for any infringement of patents or other rights of third parties which may result from its use. Adactus reserves the right to make changes without further notice to any product herein to improve reliability, function or design. Adactus does not assume any liability arising out of the application or use of any product described herein.

This publication supersedes and replaces all information previously supplied. Adactus products are not authorised as critical components in life support devices or systems.